



**3D** solutions

*A New Dimension In Design*

# Contents

**Range**

Albany

Aura

Avondale  
Berkeley

Boston

Buckingham

Gresham

Hadfield

Jura

**Style**

*Solid Timber Door Painted from Stock in -*

*Vinyl Wrapped Door in -*

*Traditional Wrapped Door in -*

*Shaker Vinyl Wrapped Door in -*

*Shaker Vinyl Wrapped Door in -*

*Five-piece Shaker PVC Door in -*

*Shaker Vinyl Wrapped Door in -*

*Solid Timber Door in -*

*Integrated Handle System for Aura, Lumi & Odyssey*

*Super Matt*

*Super Matt*

*Super Matt*

*Super Matt*

*Super Matt*

*Super Matt*

*Matt*

*Super Matt*

*Super Matt*

*Super Matt*

*Super Matt*

*Super Matt*

*Super Matt*

*Super Matt*

*Super Matt*

*Super Matt*

*Super Matt*

*Ash Embossed*

*Ash Embossed*

*Ash Embossed*

*Ash Embossed*

*Ash Embossed*

*Ash Embossed*

*Ash Embossed*

*Ash Embossed*

*Ash Embossed*

*Ash Embossed*

*Smooth*

*Matt*

*Super Matt*

*Painted*

*Painted*

**Colour**

**Porcelain**

**Dove Grey**

**Dust Grey**

**Dust Grey (Multi-Purpose Rail)**

**Navy Blue**

**Dove / Dust Grey**

**Dove Grey**

**Dusty Pink**

**Mussel**

**Navy Blue**

**White**

**Light / Dark Concrete**

**Ivory**

**Dove Grey**

**White / Dove Grey**

**Cashmere**

**Dove Grey**

**Fjord**

**Graphite**

**Mussel**

**Navy Blue**

**White**

**Reed Green**

**Cashmere**

**Fir Green**

**Dove Grey**

**Graphite**

**Indigo**

**Ivory**

**Mussel**

**Navy Blue**

**Stone Grey**

**White**

**Lissa Oak**

**Ivory**

**Kombu Green**

**Ivory / Duck Egg Blue**

**Dove Grey**

**Dove Grey Gloss (Odyssey)**

**Page**

5

6

7

8

9

10

13

14

16

17

18

19

21

23

24

27

28

29

30

31

32

33

34

37

38

39

40

41

42

43

44

45

46

47

49

50

53

55

57





**Range**

Larissa

Malham

Odyssey

Orion

Rivington

Vogue

**Style**

*Handleless Lacquered Door in - Gloss*

*Solid Timber Door in - Painted*

*Laser Edged Acrylic Door in - Gloss*

*Handleless Vinyl Wrapped Door in - Matt*

*Narrow Framed Shaker Door in - Super Matt*

*Vinyl Wrapped Door in - Gloss*

*Gloss*

*Gloss*

*Gloss*

*Gloss*

*Gloss*

*Gloss*

*Matt*

*Matt*

*Matt*

*Matt*

*Painted*

*Painted*

*Painted*

*Painted*

*Gloss*

*Gloss*

*Gloss*

*Matt*

*Matt*

*Super Matt*

*Super Matt*

*Super Matt*

*Super Matt*

*Super Matt*

*Super Matt*

*Super Matt*

*Super Matt*

*Super Matt*

*Super Matt*

*Gloss*

*Gloss*

*Gloss*

*Gloss*

*Gloss*

*Gloss*

*Gloss*

**Colour**

**Alabaster**

**Cashmere**

**Dove Grey**

**Dust Grey**

**Indigo**

**White**

**Indigo**

**Dove Grey**

**Dust Grey**

**White**

**Soft Cloud / Mussel**

**Ivory**

**Dove Grey / Midnight**

**Fjord**

**Cream**

**Dove Grey**

**White**

**Osiris Silver**

**Fjord / White**

**Light Concrete**

**Navy Blue**

**Navy Blue / Graphite**

**Cashmere**

**Dove Grey**

**Dust Grey**

**Graphite**

**Graphite / Dove Grey**

**Stone Grey**

**White**

**Alabaster**

**Cashmere**

**Dove Grey**

**Dust Grey**

**Indigo**

**White**

**White / Cashmere**

**Page**

59

60

61

62

63

64

65

66

67

68

71

72

74

75

77

78

79

80

81

83

84

85

87

88

89

90

91

92

93

95

96

97

98

100

101

102

**Colour Options 104**

**MTM Door Options 106**

**Handle Options 108**

**Lighting Options 125**

**Gola System 126**

**Storage Options 128**

**Accessory Options 132**

**Vertex Drawer Boxes 134**

**Basics Range 136**

**Door Key 137**

*All of our Kitchens can be ordered in all the colours found on our Colour Options page 110.*

*\*Some limitations in gloss*

*The colours reproduced within this brochure are as close as the reproduction process allow. Due to our policy of continuous product development, we reserve the right to alter any specifications without prior notice. Products can be introduced and discontinued at any time, it is recommended to check availability from supplier before ordering.*

*Cover image: Albany - Painted from Stock in Porcelain & Dust Grey.*

# Albany

The Narrow Solid ash shaker frame in Albany oozes both style and substance. Available from stock in 4 on trend colours or create your own unique kitchen with a choice of another 11 painted to order colours.

*Designers tip:*  
Use the multi-purpose rail to create that in-frame look.



Available from Stock in  
**Painted**

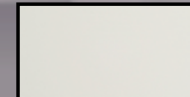

Porcelain



Dove Grey

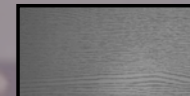

Dust Grey

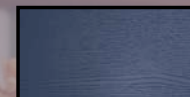

Navy Blue

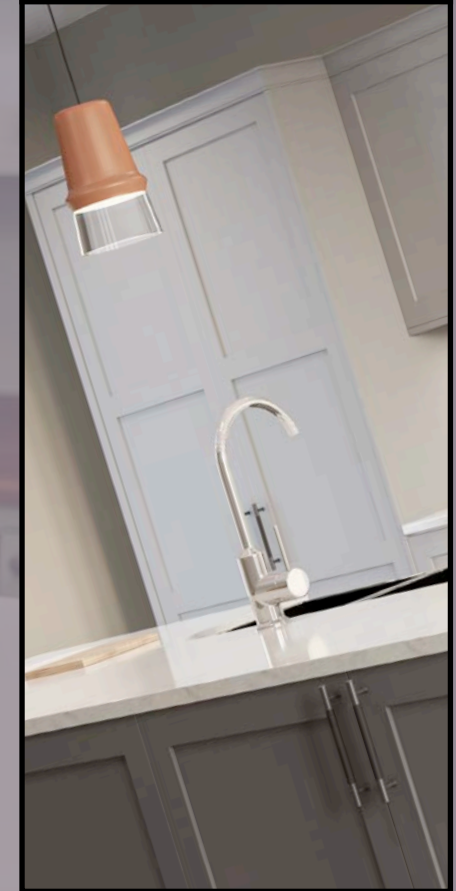





Porcelain

*Showing Navy Blue Island*



Dove Grey







Dust Grey



## Dust Grey

*Showing use of  
Multi-Purpose Rail*







Navy Blue







**Dove Grey**  
*Showing Dust Grey Island*

# Aura

A Simple Slab door finished in a tactile Super Matt finish sets up Aura as a firm favourite for lovers of modern design. Available in a range of Super Matt colours which are strong enough to work on their own or as a contrasting design for true individuality.

*Designers tip:*

*Accessorise with classic or rustic fittings and strongly grained timber worktops for a perfect contrast.*

See Inside Back Cover for DOOR KEY



## Super Matt



White

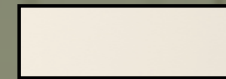

Mussel

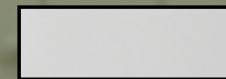

Dove Grey



Navy Blue



Graphite

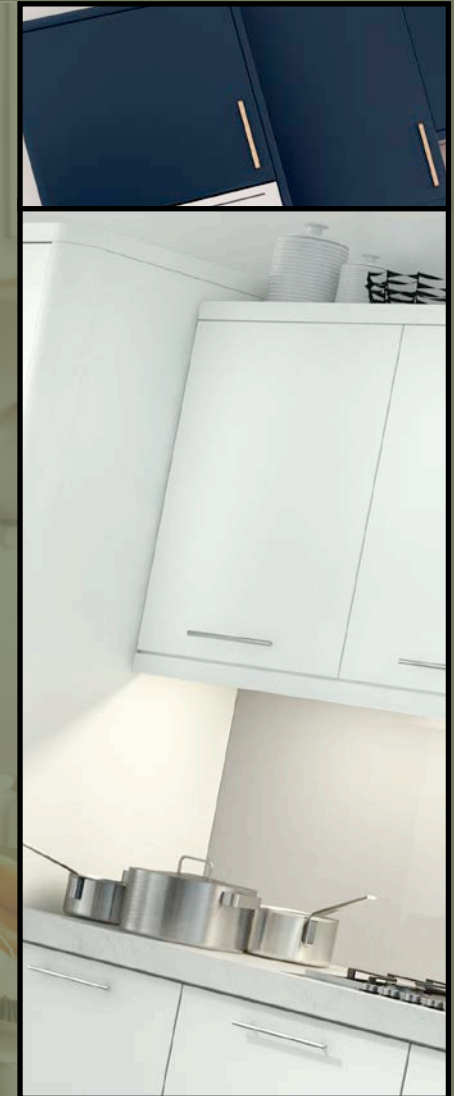





Dove Grey



## Dusty Pink

*Graphite Tall Units*

**Lumi** *Light Concrete End Panels*









Mussel





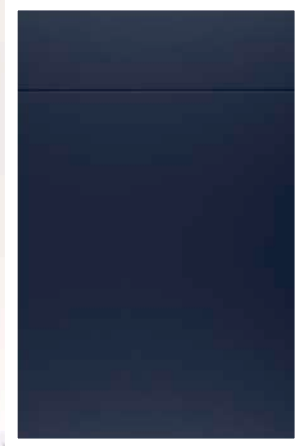

**Navy Blue**  
*Indigo Island Unit*

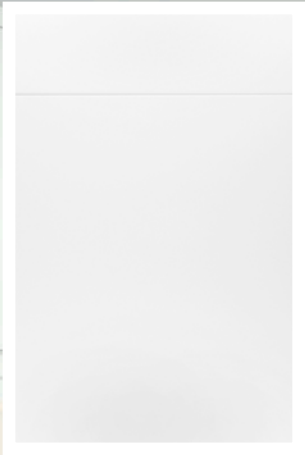

**White**  
*Dove Grey Island Unit*







Aura Light Concrete Matt & Dark Concrete Matt with Gola System  
*Made to Order*



# Avondale

*A classic tongue and groove style mid panel affords Avondale a classic cottage style featured in an ever popular ivory finish. Adding curved doors further enhances the charm of this kitchen design.*

**Designers tip:**  
*Add oak block worktops and matching tongue and groove end panels to complete the traditional appearance.*

See Inside Back Cover for DOOR KEY



**Matt**

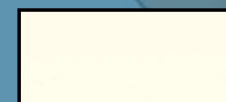

Ivory







Ivory

# Berkeley

## Made to Order

A timeless classic shaker with 65mm rails and stiles. A minimalist shaker that would suit anything from a quaint cottage to a luxury penthouse, with full Made to Order flexibility.

*Designers tip:  
Use doors as end panels to make a seamless island unit.*

See Inside Back Cover for DOOR KEY



### Super Matt

	
White	Kombu Green
	
Mussel	Stone Grey
	
Cashmere	Dust Grey
	
Dove Grey	Navy Blue
	
Fjord	Graphite
	
Dusty Pink	Indigo







**Dove Grey**  
*Graphite Island &*









Berkeley White Super Matt & Dove Grey Super Matt with Gola System

# Boston

*Boston is an update on a classic shaker design, with a wider frame and no 'V' groove. The effortless styling perfectly suits the range of five tactile, Super Matt finishes. Select a single colour or mix two for a truly individual kitchen.*

**Designers tip:**

*Radius end rails are a great addition to the subtle styling of the Boston range.*

See Inside Back Cover for DOOR KEY



## Super Matt



White

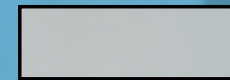

Fjord

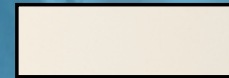

Mussel



Reed Green

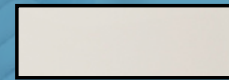

Cashmere

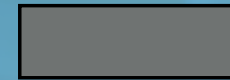

Dust Grey

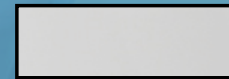

Dove Grey



Navy Blue



Graphite

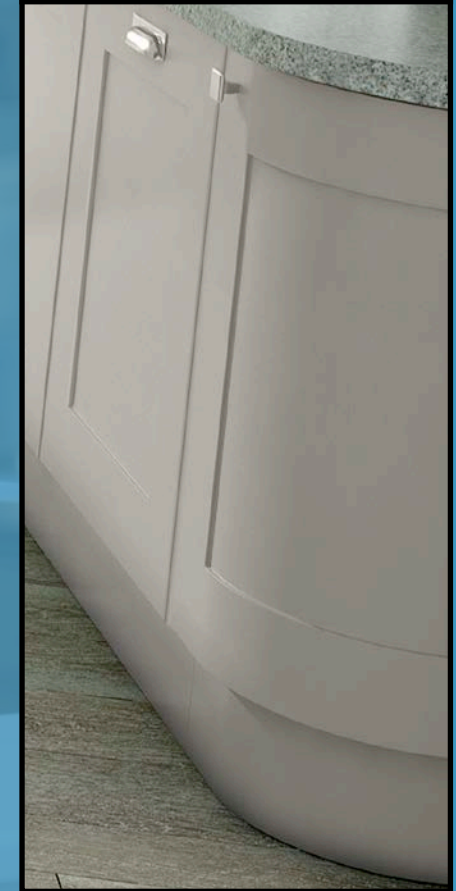





**Cashmere**  
*White Island Unit*





Dove Grey







**Fjord**  
*White Wall & Base Units*



## Graphite

*Dust Grey Wall & Base Units*







**Mussel**

*Dove Grey Wall & Base Units*



## Navy Blue

*Graphite Island Unit  
& Overmantle*







White



Reed Green





# TRITON KITCHEN



# Buckingham

The Buckingham design, featuring a wide frame and 'V' grooved joints, blends a traditional shaker design with modern colours featuring a distinctive ash effect woodgrain. The result is a timeless kitchen suited equally well to either traditional or contemporary surroundings.

*Designers tip:*

*Add Radius Rails for a sleek modern finish.*

See Inside Back Cover for DOOR KEY



## Ash Embossed



White



Stone Grey

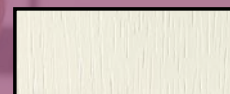

Ivory

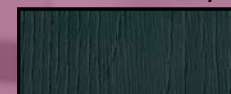

Fir Green

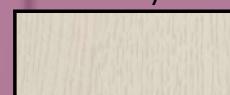

Cashmere

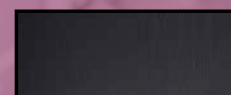

Graphite



Dove Grey

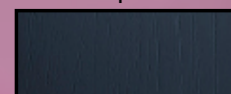

Navy Blue

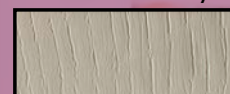

Dakar

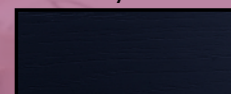

Indigo

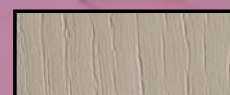

Mussel

## Woodgrain

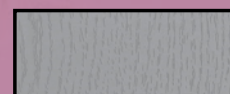

Dust Grey

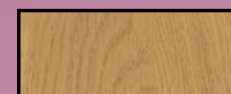

Lissa Oak







Cashmere Ash





Fir Green Ash

# AWAITING IMAGINE





Dove Grey Ash





Graphite Ash







Indigo Ash





Ivory Ash







Mussel Ash





Navy Blue Ash







Stone Grey Ash







White Ash







Lissa Oak

# Gresham

*Stylish & chic, Gresham is classic in both form and function. A stunning Shaker-style door provides elegance in any sized kitchen. A timeless design perfectly matched with a range of feature accessories.*

**Designers tip:**

*Experiment with feature accessories like Curved Doors, T & G End Panels & maybe an Overmantle to create your own style statement.*

See Inside Back Cover for DOOR KEY



**Matt**



Ivory







Ivory







Kombu Green

*Made to Order*

# Hadfield

A narrow-framed timber shaker with a beading, Hadfield is a stunning example of a traditional door with a modern painted twist. Create your dream kitchen by using one or more of the 15 stunning painted colours on offer.

**Designers tip:**

*Use of an Overmantle, gives a more traditional feel to this classic painted kitchen.*

See Inside Back Cover for DOOR KEY



## Painted to Order Palette

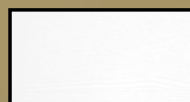

White

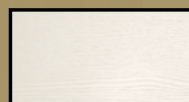

Ivory

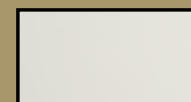

Porcelain

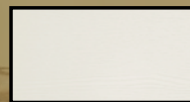

Cashmere

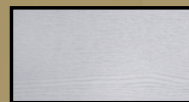

Dove Grey

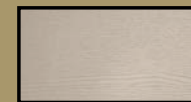

Mussel

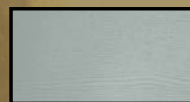

Duck Egg Blue

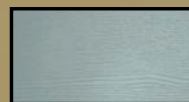

Fjord

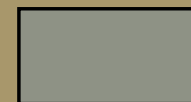

Reed Green

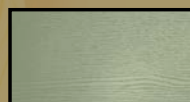

Sage

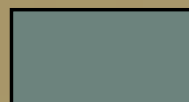

Atlantic Green



Dust Grey



Navy Blue



Graphite

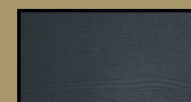

Noir Blue







**Ivory**  
*Duck Egg Blue Island*



*White*

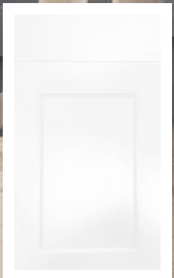

*Ivory*

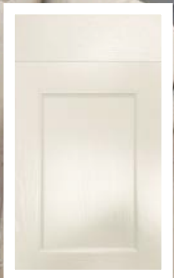

*Porcelain*

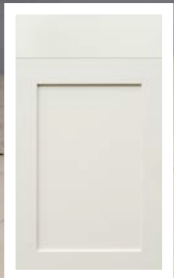

*Cashmere*



*Dove Grey*



*Mussel*



*Duck Egg Blue*



*Fjord*







**Dove Grey**  
Cashmere Wall Units  
Graphite Island

*Reed Green*



*Sage*



*Atlantic Green*



*Dust Grey*



*Navy Blue*



*Graphite*



*Noir Blue*



# Jura

## Integrated Handle Made to Order

Available in Brushed & Chrome, Jura is a full width Integrated Handle for use with our Aura, Lumi & Odyssey Ranges. Created in 12 fixed widths & ordered with your chosen doors, so they can be supplied grooved ready for the handle to be inserted. Universally Rotated to suit Wall units and Base units alike, a truly versatile, low Installation option for any Kitchen.

### Fixed Widths Available (mm)

147	247	297	347	397	447	497	547	597	797	897	997
-----	-----	-----	-----	-----	-----	-----	-----	-----	-----	-----	-----

Brushed



Chrome

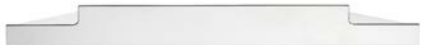

Aura & Chrome Jura



Lumi & Chrome Jura



Odyssey & Chrome Jura



All colours are as close as the reproduction process allows.





Dove Grey

Odyssey Dove Grey Gloss with Jura Integrated Handle

Made to Order

# Larissa

Larissa offers sleek, stunning lines for a truly modern look. With an integrated handle design and finished in either a high quality lacquered Gloss, available in 5 colours, or 3 contemporary Matt finishes - Larissa is set to become a fashionable classic.

**Designers tip:**

Use wide, deep pan drawers with internal and external corner posts to continue the handle line around corners.

See Inside Back Cover for DOOR KEY



## Gloss

## Matt

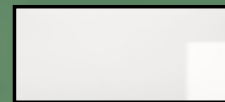

White



White

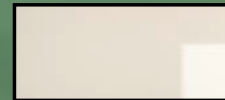

Alabaster

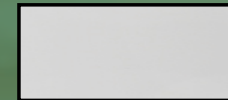

Dove Grey

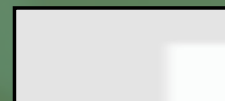

Dove Grey



Dust Grey

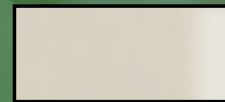

Cashmere



Indigo



Dust Grey



Indigo



Integrated Handle





Alabaster  
Gloss





**Cashmere**  
*Gloss*







Dove Grey  
Gloss





**Dust Grey**  
*Gloss*





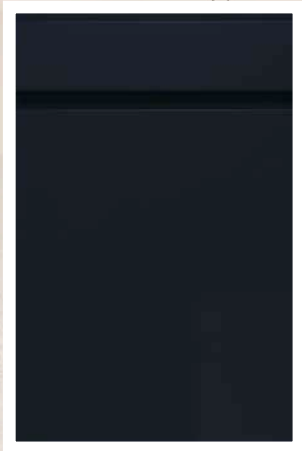

**Indigo**  
*Gloss*



White  
Gloss





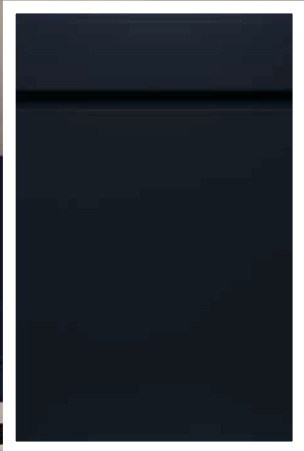

Indigo  
Matt





Dove Grey  
Matt

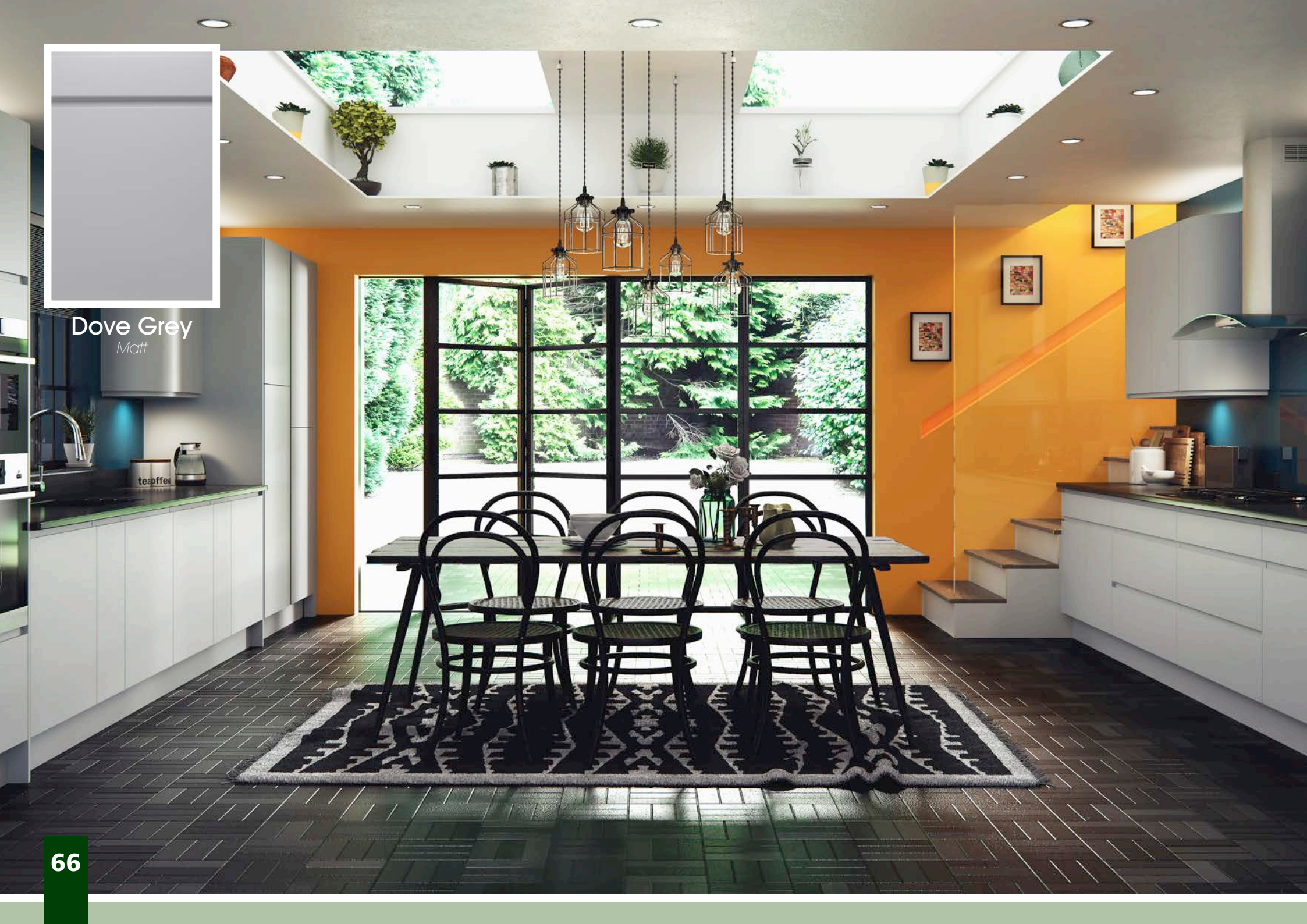



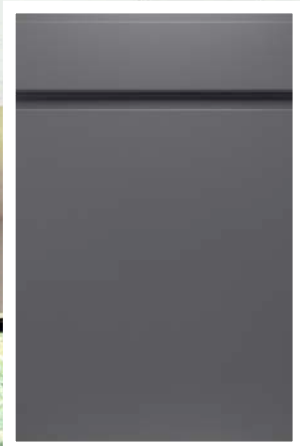

Dust Grey  
Matt









**White**  
*Matt*

# Malham

A classic solid timber shaker design offering a blend of traditional materials merged with modern finishes. Choose from painted ivory with its subtle grain to painted Noir Blue for a dramatic statement, or go a stage further and select from a range of 21 carefully selected paint colours to create a stunning kitchen.

**Designers tip:**

Add curved doors and light coloured stone worktops to create the wow factor.

See Inside Back Cover for DOOR KEY

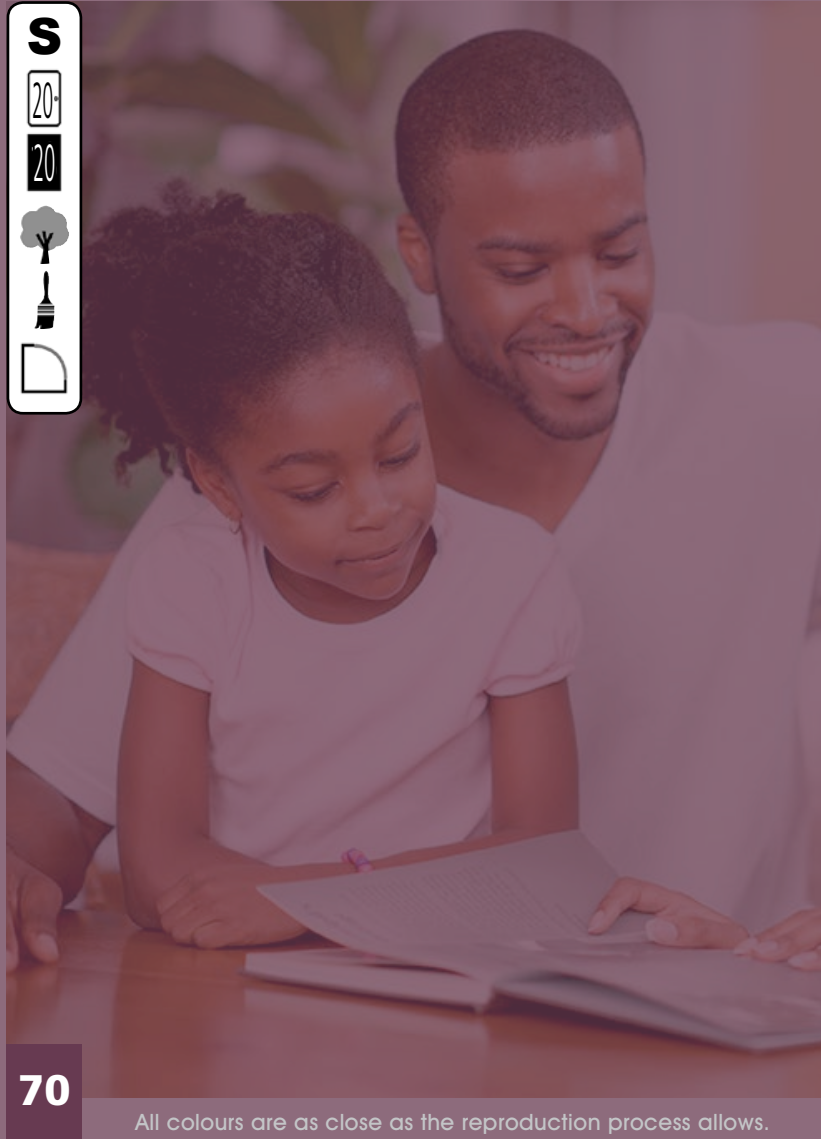

### Painted to Order Palette

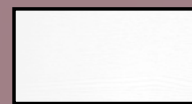

White

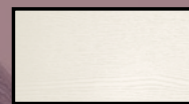

Ivory

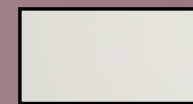

Porcelain

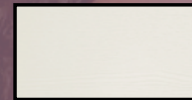

Cashmere



Dove Grey



Mussel



Duck Egg Blue

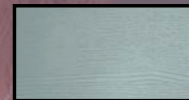

Fjord



Reed Green

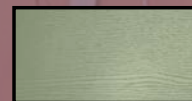

Sage



Atlantic Green

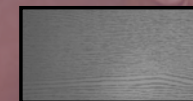

Dust Grey



Navy Blue



Graphite

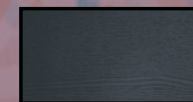

Noir Blue

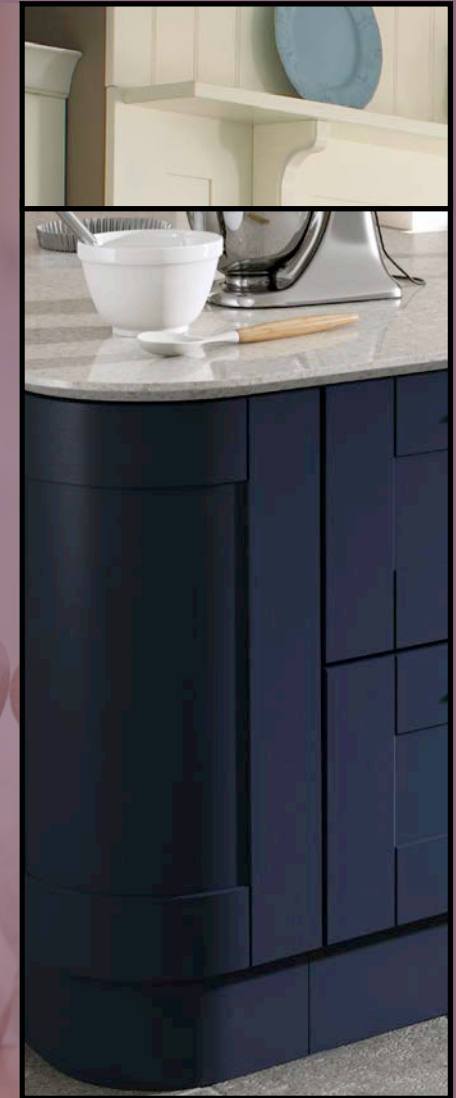





Soft Cloud  
*Mussel Island*



*White*



*Ivory*



*Porcelain*



*Cashmere*



*Dove Grey*



*Mussel*



*Duck Egg Blue*



*Fjord*







Ivory

Reed Green



Sage



Atlantic Green



Dust Grey



Navy Blue



Graphite

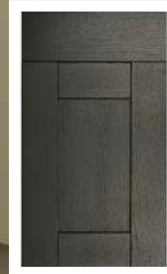

Noir Blue





**Dove Grey**  
*Midnight Island*



*White*

*Ivory*

*Porcelain*

*Cashmere*

*Dove Grey*

*Mussel*

*Duck Egg Blue*

*Fjord*







**Fjord**

*Reed Green*



*Sage*



*Atlantic Green*



*Dust Grey*



*Navy Blue*



*Graphite*



*Noir Blue*



# Odyssey

Made to Order

See Inside Back Cover for DOOR KEY



Odyssey shouts contemporary, a cutting edge, flat slab door available in a range of top quality High Gloss, Super Matt, Metallic & MFC Abstract finishes. Combine these options with the market leading Laser Edge banding to create a real impression. Use curved doors for a softer, rounded look, or clad with contrasting end panels for a striking, modern kitchen

*Designers tip:*

Mix with stone or timber worktops and slim bar handles for a clean, fashionable look.

## High Gloss

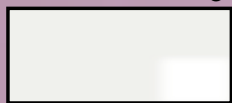

White

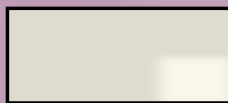

Cream

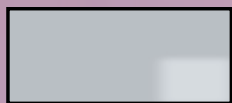

Dove Grey

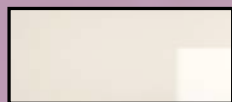

Champagne Metallic

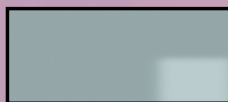

Blue Metallic

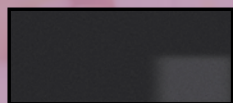

Anthracite Metallic



Matching Edge

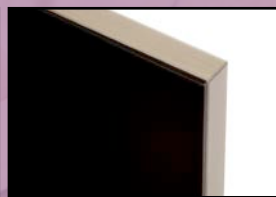

Two Tone Edge

Odyssey Laser Edged **GLOSS** Doors are available with either a Matching or Two Tone Edge.

## Super Matt



White

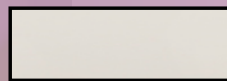

Cashmere



Dove Grey



Fjord



Kombu Green



Dust Grey

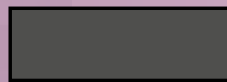

Graphite



Indigo

## MFC



Osiris Silver

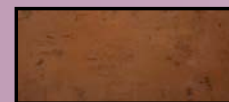

Osiris Copper

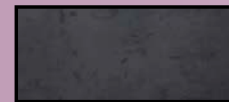

Osiris Graphite

**Super Matt** are only available with a Matching Edge.

**MFC** are only available with a Matching Edge.





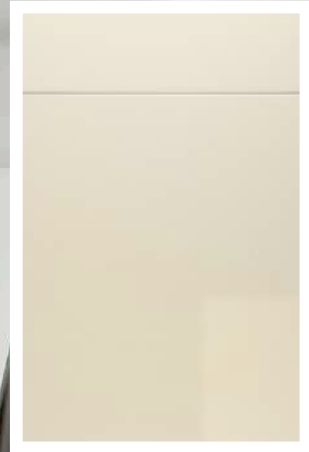

Cream



Dove Grey







White





## Osiris Silver

*Osiris Copper Top Units  
& Osiris Graphite Wall Units*







Odyssey Fjord & White Super Matt with Gola System

# Orion

## Made to Order

Orion, with its Integrated Handle design, available Made to Order & shown here in our ever popular Super Matt paint effect finishes. Truly is a universal design and lends itself, not just as a great kitchen option, but also a superb solution to Home Living & Home Office creations.

**Designers tip:**

*Utilise the full range colour palette to mix and match for a contrasting finish.*

See Inside Back Cover for DOOR KEY



Flip Doors & Drawers for  
a Creative Handle effect

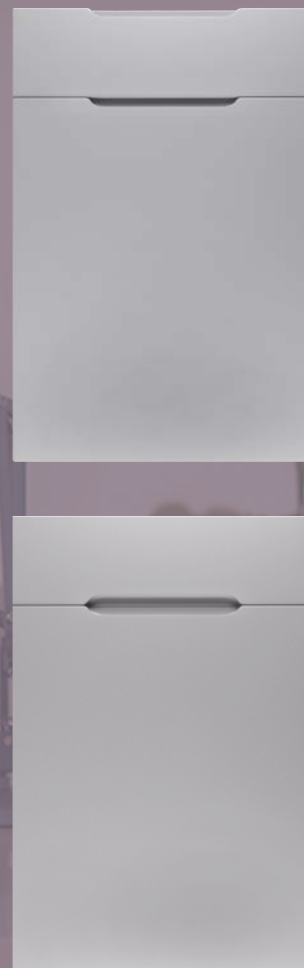





Orion Light Concrete & Lumi Graphite Super Matt









Orion Navy Blue & Graphite Super Matt

# Rivington

The Narrow-Framed shaker Rivington design in sleek Super Matt paint effect finishes. Traditional design in the latest colour trends are perfect at home in the trendiest loft, or in a cosy cottage.

*Designers tip:*  
Excellent colour palette well suited to mix and match for contrast.

See Inside Back Cover for DOOR KEY



## Super Matt

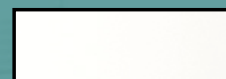

White

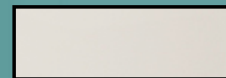

Cashmere

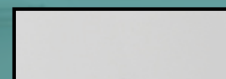

Dove Grey

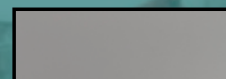

Stone Grey

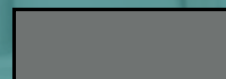

Dust Grey



Graphite







Cashmere





Dove Grey







Dust Grey





Graphite







## Graphite

*Dove Grey Wall Units  
& Overmantle*





Stone Grey





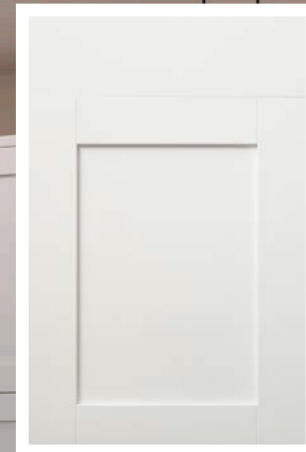

White



# Vogue

*A Contemporary, lacquered high gloss minimalist slab door. Effortlessly modern and offering an understated elegance, Vogue suits modern kitchen layouts and works equally well in small or large settings. Available in five colours including ever popular Dove Grey.*

*Designers tip:*

*Vogue is perfect for the smaller kitchen as the gloss finish bounces light around the room.*

See Inside Back Cover for DOOR KEY



## Gloss

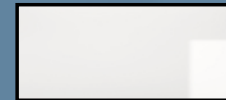

White

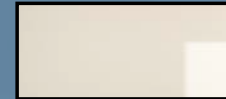

Alabaster

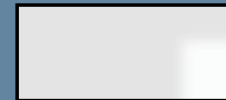

Dove Grey



Cashmere



Dust Grey

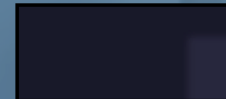

Indigo

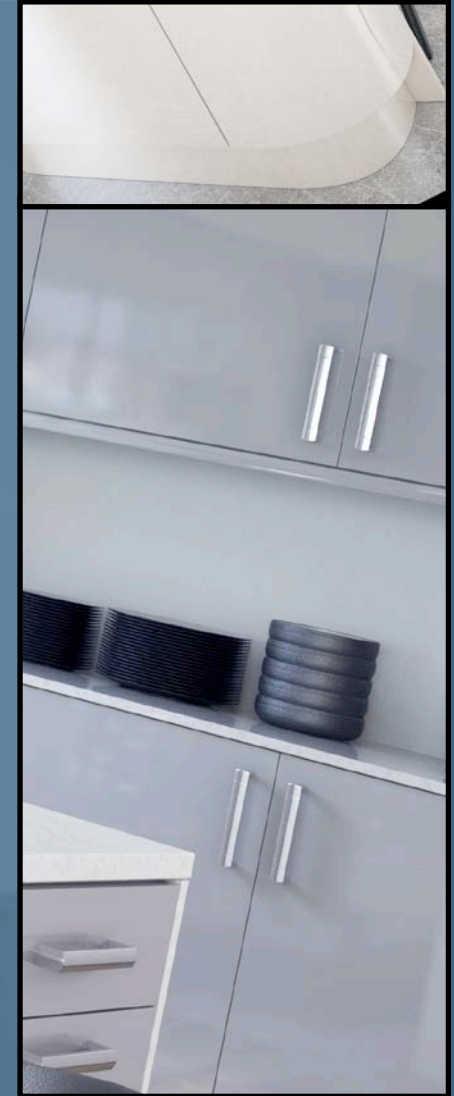





Alabaster





Cashmere







Dove Grey









Dust Grey





Indigo







White







Vogue White & Cashmere Gloss with Gola System

# Colour Options

All Stock Vinyl and Made To Order doors are available in the vinyls below, with some limitations in gloss.

## Matt



White Classic



Porcelain

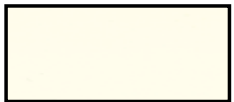

Ivory

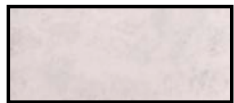

Concrete  
(Light)



Dakar



Concrete  
(Dark)

## Super Matt



White



Mussel

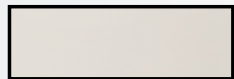

Cashmere

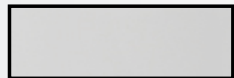

Dove Grey

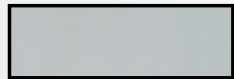

Fjord



Dusty Pink



Reed Green



Kombu Green

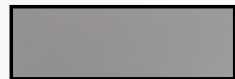

Stone Grey



Dust Grey



Navy Blue



Graphite



Indigo

## Ash Embossed



White



Ivory



Cashmere



Dove Grey



Dakar



Mussel

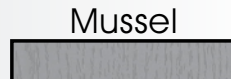

Dust Grey



Stone Grey

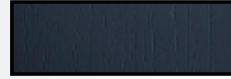

Navy Blue



Indigo

## Woodgrain



Natural  
Halifax Oak



Lissa Oak



Sonoma Oak

## Gloss



White

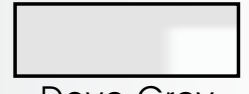

Dove Grey



Cream

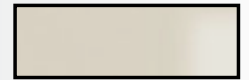

Cashmere



Dust Grey



## Odyssey Gloss

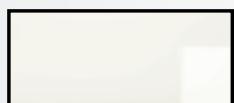

White

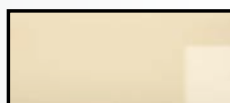

Cream



Dove Grey



Champagne Metallic



Blue Metallic



Anthracite Metallic



Matching Edge



Two Tone Edge

*Odyssey Laser Edged **GLOSS** Doors are available with either a Matching or Two Tone Edge.*

## Odyssey Super Matt



White

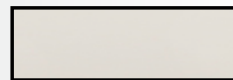

Cashmere



Dove Grey



Fjord



Kombu Green



Dust Grey

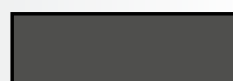

Graphite

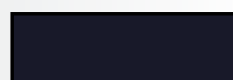

Indigo

***Super Matt** are only available with a Matching Edge.*

## Odyssey MFC



Osiris Silver



Osiris Copper

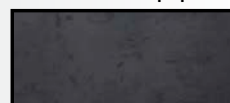

Osiris Graphite

***MFC** are only available with a Matching Edge.*

## Albany, Hadfield & Malham

Painted to Order Palette



White

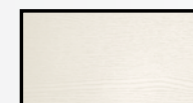

Ivory

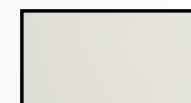

Porcelain

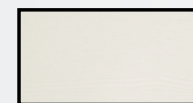

Cashmere



Dove Grey



Mussel

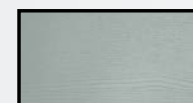

Duck Egg Blue

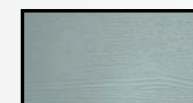

Fjord



Reed Green

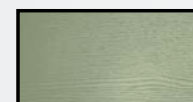

Sage



Atlantic Green

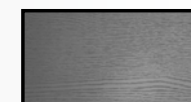

Dust Grey



Navy Blue



Graphite

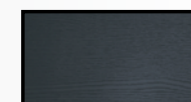

Noir Blue

# MTM Door Options



Aries

**A B G**



Ascot

**B G**



Auckland

**B**



Aura

**A B C S**



Aura Jura

**S**



Euroline

**A B G**



Gemini

**C G**



Gisburn

**A B G**



Gresham

**A B C**



Hampshire

**A B G**



Hapton

**A B G**



Hebden

**A B G**



Orion

**B G**



Oxford

**A B C**



Richmond

**B G**



Salisbury

**A B**



Sherwood

**B G**



Westport

**A B G**





Avondale

**BC**



Berkeley

**ABC**



Boston

**BC**



Bowland

**ABC**



Bury

**ABG**



Countryvale

**ABG**



Dover

**ABG**



Kent

**B**



Lumi

**ABCG**



Lumi Jura

**G**



Mayfair

**BC**



Milan

**ABC**

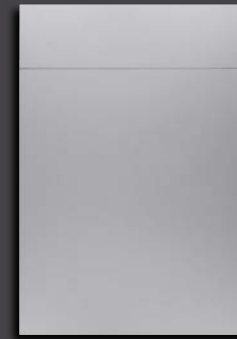

Odyssey\*

**BCG**



Odyssey Jura\*

**G**

## MTM Door Options Key:

- A** *Angled Doors Available*
- B** *Bedroom Doors Available*
- C** *Curved Doors Available*
- G** *Gloss Doors Available*
- S** *Only Available in Super Matt*

# Handle Options

No.01



Oval tube 'D' handle, aluminium centre with die-cast legs, 160mm Bar Handle, Brushed Nickel

No.03



156mm 'T' Bar Handle, Brushed Nickel

No.04



Shaker 'D' handle, 96mm Satin Nickel

No.09



Shaker 'D' handle, 96mm Antique English

No.11



30mm Windsor Knob & Plate Chrome

No.12



40mm Windsor Knob Chrome

No.13



160mm Windsor Handle Chrome

No.14



96mm Windsor Handle Chrome



No.15



128mm Windsor Latch Handle Chrome

No.16



30mm Westminster Knob Chrome

No.17



64mm Windsor Shell Handle Chrome

No.18



96mm Windsor Shell Handle Chrome

No.21



Reeded drop handle, 160mm Pewter

No.22



Reeded 'T' knob handle, 70mm Pewter

No.23



Archer bow handle, 128mm Shiny Chrome

No.24



Roundel 'D' handle, 128mm Satin Chrome

No.26



*Dimple tapered bow handle, 128mm Satin Chrome*

No.27



*Parallel bowed rod handle, 192mm Brushed Nickel*

No.28



*Parallel bowed rod handle, 320mm Brushed Nickel*

No.29



*'T' bar handle, 387mm Brushed Nickel*

No.31



*Oval tube 'D' handle, aluminium centre with diecast legs, 320mm Brushed Nickel*

No.32



*Oval tube 'D' handle, aluminium centre with diecast legs, 512mm Brushed Nickel*

No.33



*Angled boss bar handle, 195mm Brushed Nickel*

No.34



*Angled boss bar handle, 392mm Brushed Nickel*



No.35



Angled boss bar handle, 635mm Brushed Nickel

No.36



Dimpled knob handle, 33mm Brushed Nickel

No.37



Dimpled bow handle, 128mm Brushed Nickel

No.38



Taper strap handle, 96mm Satin Nickel

No.39



Hammered 'D' handle, 128mm Pewter

No.45



Valentino 'D' handle, 96mm Pewter

No.46



Valentino Latch handle, 96mm Pewter

No.47



Titan 'D' handle & back plate, 64mm Pewter

No.48



Titan Latch handle & back plate, 64mm Pewter

No.49



*Hammered knob, 32mm Pewter*

No.51



*Knob handle, 32mm Satin Nickel*

No.60



*Keyhole bar handle, 128mm Brushed Nickel*

No.61



*Keyhole bar handle, 156mm Brushed Nickel*

No.62



*Keyhole bar handle, 256mm Brushed Nickel*

No.63



*Keyhole bar handle, 306mm Brushed Nickel*

No.64



*Keyhole bar handle, 356mm Brushed Nickel*

No.65



*Keyhole bar handle, 456mm Brushed Nickel*

No.66



*Keyhole bar handle, 632mm Brushed Nickel*



No.80



Aries bar handle, 160mm Brushed Nickel

No.81



Aries bar handle, 214mm Brushed Nickel

No.82



Aries bar handle, 310mm Brushed Nickel

No.83



Aries bar handle, 374mm Brushed Nickel

No.84



Aries bar handle, 474mm Brushed Nickel

No.85



Aries bar handle, 502mm Brushed Nickel

No.90



Flat curve rod handle, 96mm Chrome

No.91



Flat curve rod handle, 146mm Chrome

No.92



Flat curve rod handle, 196mm Chrome

No.93



Flat curve rod handle, 246mm Chrome

No.94



Flat curve rod handle, 296mm Chrome

No.99 - HAMPSHIRE



Hampshire 128mm Letter Box Handle

No.100



'T' bar handle, 96mm Hollow Brushed Nickel

No.101



'T' bar handle, 128mm Hollow Brushed Nickel

No.102



'T' bar handle, 160mm Hollow Brushed Nickel



No. 103



'T' bar handle, 177mm Hollow Brushed Nickel

No. 104



'T' bar handle, 256mm Hollow Brushed Nickel

No. 105



'T' bar handle, 357mm Hollow Brushed Nickel

No. 110



320mm Euston Strap Handle, Brushed Nickel

No. 111



160mm Euston Strap Handle, Brushed Nickel

No. 112



320mm Euston Strap Handle, Chrome

No. 113



160mm Euston Strap Handle, Chrome

No. 114



320mm Euston Strap Handle, Pewter

No. 115



160mm Euston Strap Handle, Pewter

No.120 - 126

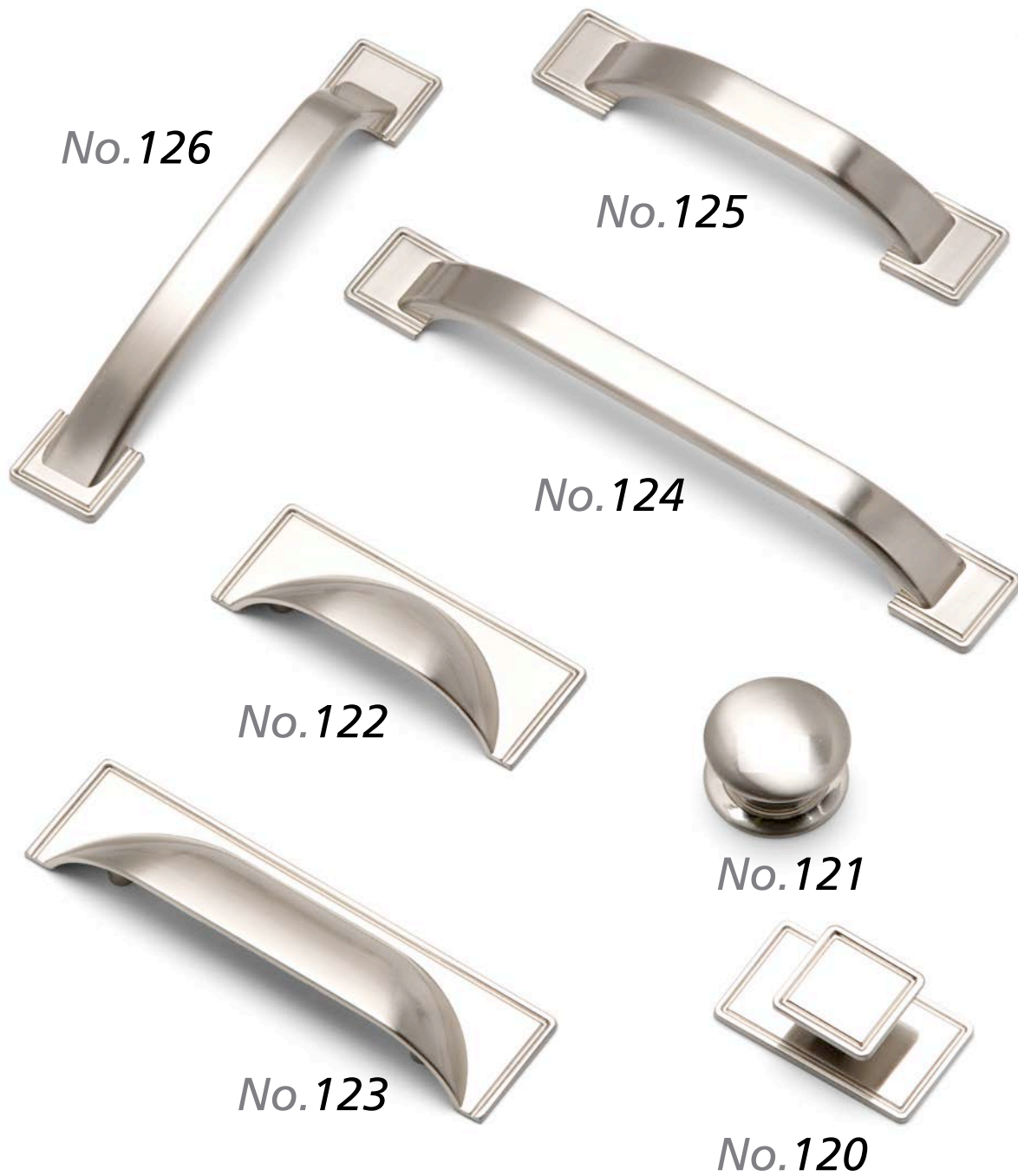

No.126

No.125

No.124

No.122



No.121

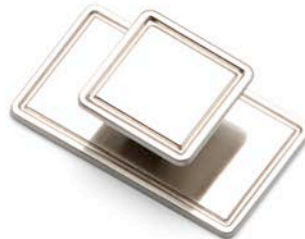

No.120

No.123

No.120 - 30mm Windsor Knob & Plate  
No.121 - 40mm Windsor Knob  
No.122 - 64mm Windsor Shell Handle  
No.123 - 96mm Windsor Shell Handle

No.124 - 160mm Windsor Handle  
No.125 - 96mm Windsor Handle  
No.126 - 128mm Windsor Handle  
All finished in Brushed Nickel

No.130



40mm Windsor Knob, Pewter

No.131



64mm Windsor Shell Handle, Pewter

No.132



96mm Windsor Shell Handle, Pewter



No. 133



96mm Camden Shell Handle, Brushed Nickel

No. 134



320mm Camden Handle, Brushed Nickel

No. 135



160mm Camden Handle, Brushed Nickel

No. 136



96mm Camden Shell Handle, Chrome

No. 137



320mm Camden Handle, Chrome

No. 138



160mm Camden Handle, Chrome

No. 139



96mm Camden Shell Handle, Pewter

No. 140



320mm Camden Handle, Pewter

No. 141



160mm Camden Handle, Pewter

No.142 - 145

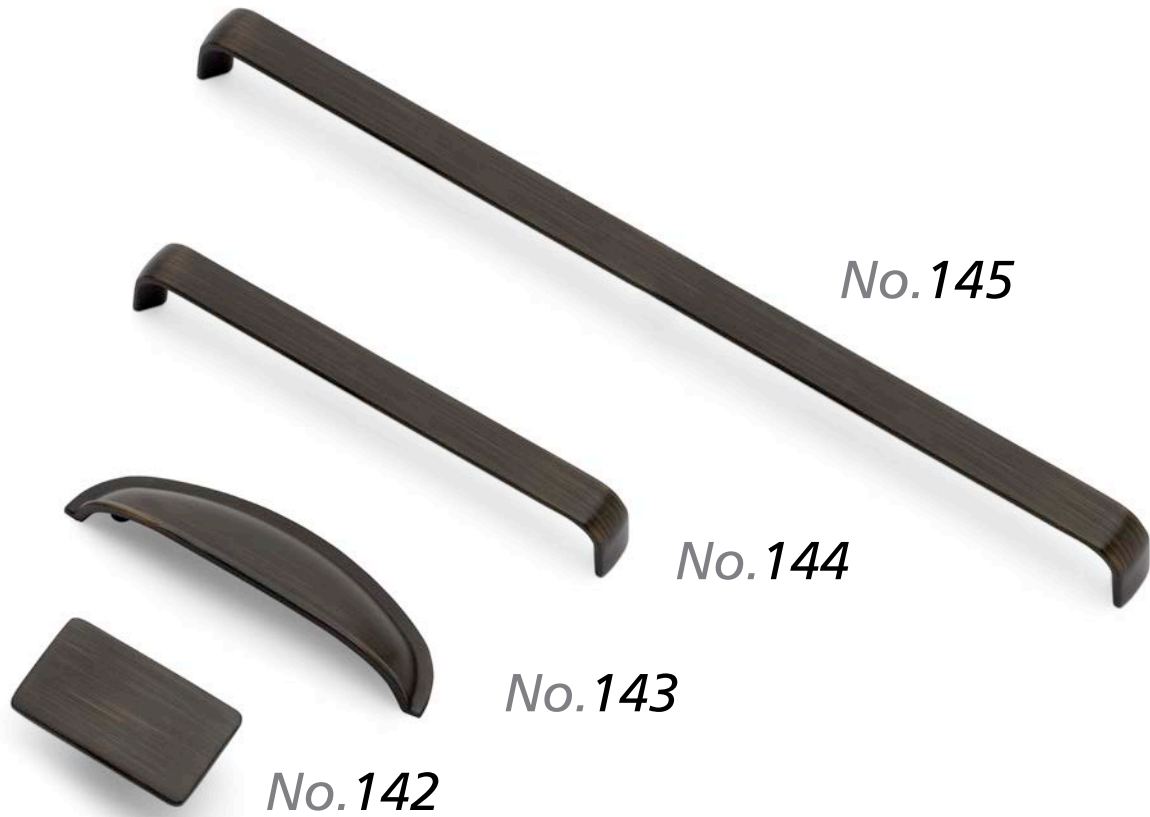

**No.142** - Camden Rectangular Knob  
**No.143** - 96mm Camden Shell Handle

**No.144** - 160mm Camden Handle  
**No.145** - 320mm Camden Handle  
All finished in Antique Black

No.150



320mm Soho Strap Handle, Brushed Nickel

No.151



160mm Soho Strap Handle, Brushed Nickel

No.152



320mm Soho Strap Handle, Chrome

No.153



160mm Soho Strap Handle, Chrome

No.154

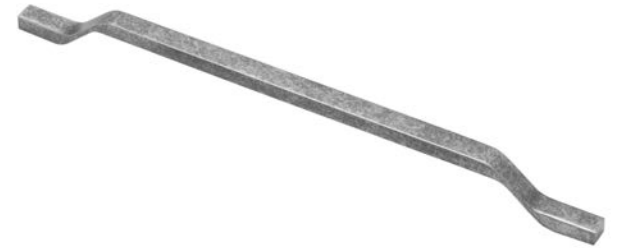

320mm Soho Strap Handle, Pewter



No. 155



160mm Soho Strap Handle, Pewter

No. 160



35mm Beehive Knob, Brushed Nickel

No. 161



35mm Beehive Knob, Chrome

No. 165



40mm Windsor Knob, Antique Copper

No. 166



160mm Camden Handle, Antique Copper

No. 167



320mm Camden Handle, Antique Copper

No. 168



96mm Camden Shell Handle, Antique Copper

No. 170



59mm Camden Rectangular Knob, Antique Copper

No. 171



59mm Camden Rectangular Knob, Brushed Nickel

No.172



59mm Camden Rectangular Knob, Chrome

No.173



59mm Camden Rectangular Knob, Pewter

No.180



65mm Crofton Trim Handle, Antique Copper

No.181

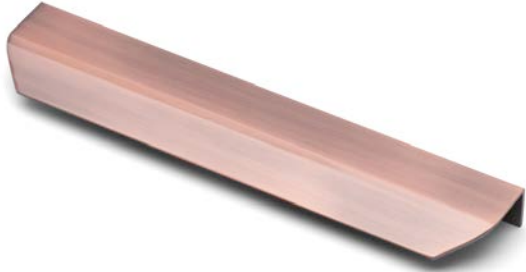

200mm Crofton Trim Handle, Copper Antique

No.182



65mm Crofton Trim Handle, Black

No.183



200mm Crofton Trim Handle, Black

No.184



65mm Crofton Trim Handle, Brushed Nickel

No.185



200mm Crofton Trim Handle, Brushed Nickel

No.186



65mm Crofton Trim Handle, Satin Chrome



No.187



200mm Crofton Trim Handle, Satin Chrome

No.190



160mm Lany Knurled Handle, Copper & Chrome

No.191



160mm Lany Knurled Handle, Black & Chrome

No.192



160mm Lany Knurled Handle, Pewter & Chrome

No.200



30mm Fender Knob, Black Smoked

No.201



160mm Fender Handle, Black Smoked

No.202



30mm Fender Knob, Chrome

No.203



160mm Fender Handle, Chrome

No.204



30mm Fender Knob, Satin Brass

No.205



160mm Fender Handle, Satin Brass

No.210



160mm Brixton Handle, Antique Copper

No.211



160mm Brixton Handle, Brushed Satin Nickel

No.212



160mm Brixton Handle, Chrome

No.213



160mm Brixton Handle, Pewter

No.214



160mm Brixton Handle, Satin Brass

No.220



128mm Crackle Handle, Chrome/White

No.221



35mm Crackle Knob, Chrome/White

No.222



Crackle 'T' Knob, Chrome/White



No.230



40mm Camden Oval Knob, Chrome

No.231



40mm Camden Oval Knob, Brushed Nickel

No.232



40mm Camden Oval Knob, Pewter

No.233



40mm Camden Oval Knob, Antique Copper

No.240



160mm Lambeth Handle, Antique Black

No.241



160mm Lambeth Handle, Pewter

No.242



320mm Lambeth Handle, Antique Black

No.243



320mm Lambeth Handle, Pewter

No.250



160mm Brent Handle, Chrome

No.251



160mm Brent Handle, Brushed Nickel

No.252



160mm Brent Handle, Pewter

No.253



320mm Brent Handle, Chrome

No.254



320mm Brent Handle, Brushed Nickel

No.255



320mm Brent Handle, Pewter

No.260



160mm Bexley Handle, Chrome

No.261



160mm Bexley Handle, Brushed Nickel

No.262



160mm Bexley Handle, Pewter

No.263



No.264



No.265



320mm Bexley Handle, No.263 - Chrome,  
No.264 - Brushed Nickel, No.265 - Pewter



# Lighting Options

No.33



Quattro Recessed LED Light

No.40



Rimini Recessed / Surface Mounted LED Light  
Available in Nickel or Chrome (shown)

No.30



Starbright Square LED Square Light

No.31



Starbright Square LED x3 Light Kit  
(Includes Power Module for up to 6)

No.37



Plinth Light 15mm Round Light

No.38



Plinth Light 15mm Round x4 Light Kit  
(Includes Power Module for up to 10)

No.42



Como High Output LED Cabinet Light in Nickel

No.44



Power Tech Module Stainless Steel Effect  
102mm Diameter, x3 240v & x2 USB 500ma Sockets

No.45-60



Corsica LED Strip Lights. Available in various lengths,  
Corner Fit, 'Y'-Splitters and Door Sensors

# Gola System

*The Gola System can be used to produce a stylish contemporary finish, with no need for filler panels and with NO restrictions on panel or door widths (the only restrictions are the heights of Base units), giving a much sleeker look and a more modern appearance - making it perfectly suited to our extensive Made to Order Ranges .*

*Our Vogue Stock Range has been specifically developed with specific Gola sizes in mind for a 'No-Fuss straight off the shelf ' solution.*

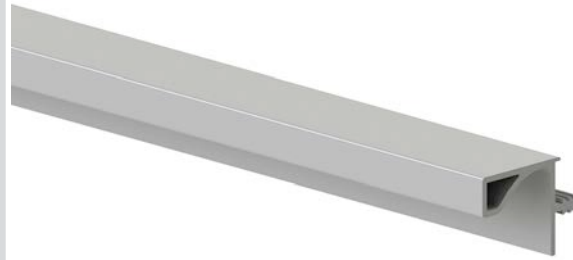

Wall Profile



Upper Profile



Central Profile



Verticle Profile

**Available from Stock in**

Matt Anodised

Anthracite



## Base Units & Wall Doors

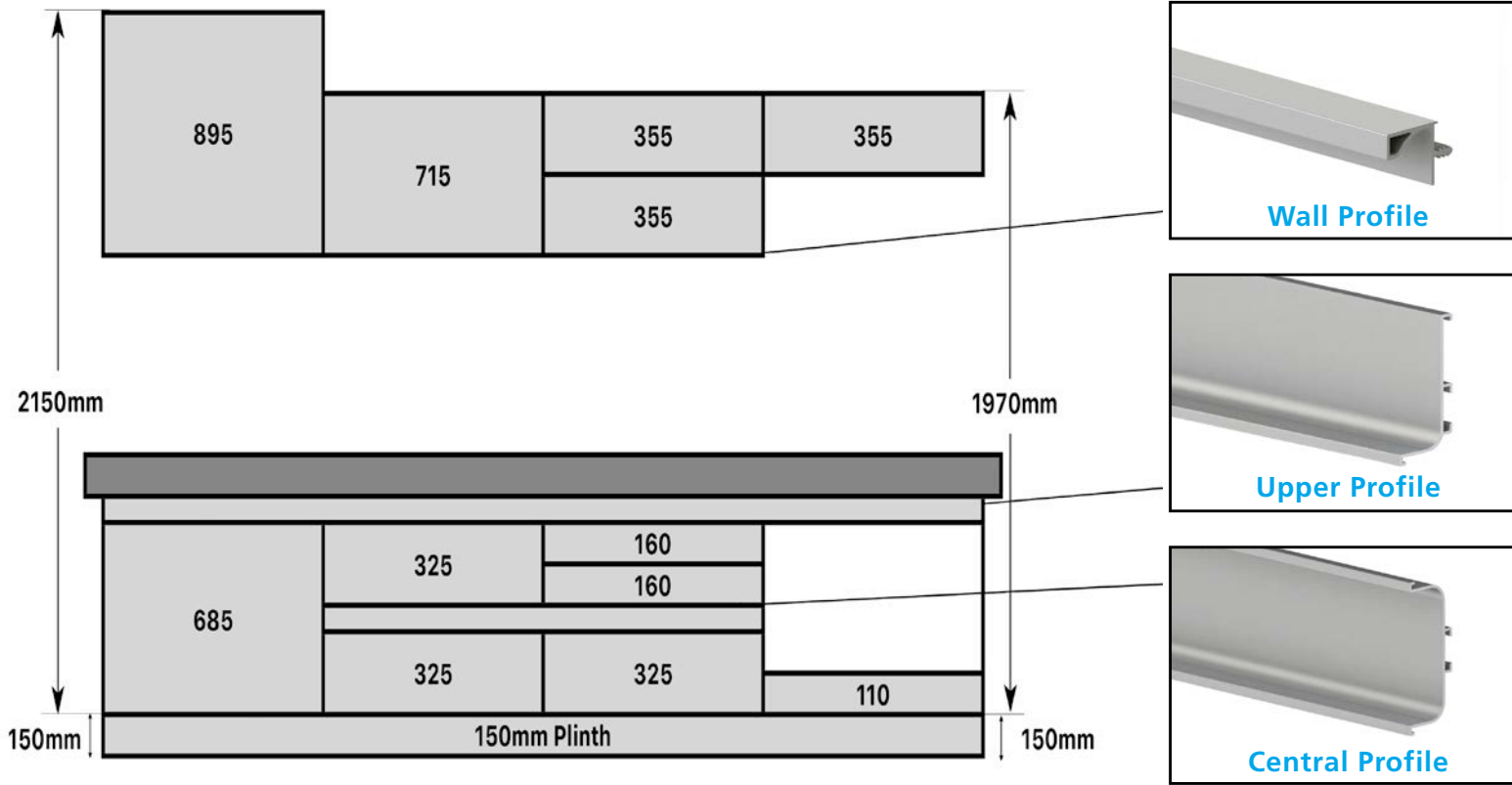

## Larder Doors & Appliance Fitting (Compatible with Integrated Appliances)

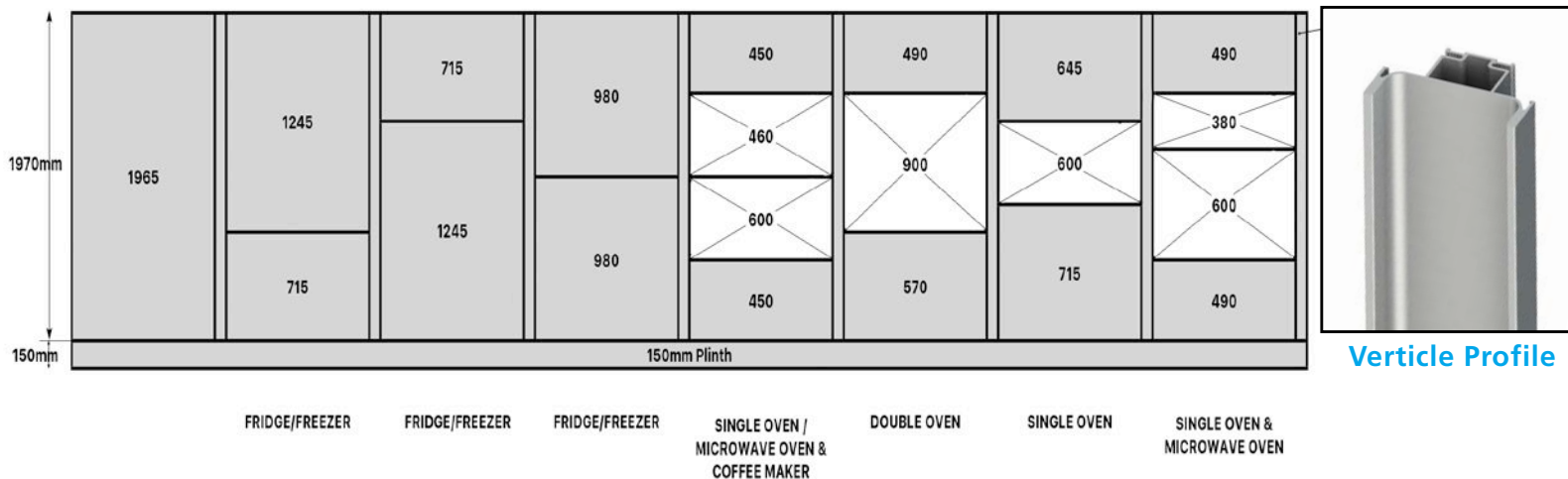

All colours are as close as the reproduction process allows.



# Storage Options



150mm Pull Out Unit



300mm Base Pull Out - Left & Right Versions available,  
400mm also available



Individual Pull Out Chrome Wire Baskets - Available in 300, 400, 500, 600, 800, 900 & 1000mm





*3/4 Corner Carousel to suit 900mm 'L' Shaped Corner Base Unit*



*Ultimate Carousel to suit 900mm 'L' Shaped Corner Base Unit*





1/2 Corner Carousel - Available in 900 (450mm Door) & 1000 (500/600mm Door)



Pull Out Corner Shelf to suit 1000mm Base Unit - Available in Left or Right Corner Unit



Universal Corner Optimiser - Available in Left or Right Corner Unit, to suit Bases 800, 900, 1000



Corner Organiser - Available in 900mm & 1000mm  
Available in Left or Right Corner Unit





2 Section short Wastebin 450mm



3 Section Wide Tall Wastebin 600mm

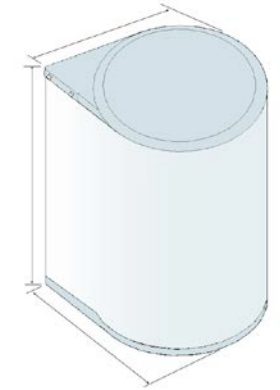

Single Section Wastebin 15L



3 Section Narrow Wastebin 400mm



3 Section Narrow Wastebin 300mm



3 Section Wastebin - Available in 500mm (45L) & 600mm (56L)



2 Section Wastebin - Available in 500mm (45L) & 600mm (56L)



Supra Pull Out Module - Universal Left or Right Soft Close  
Designed specifically to utilise unit space

# Accessory Options

No.01

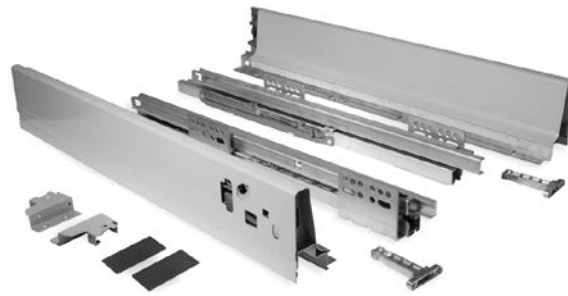

Soft Close Drawer Box Kit 1 270mm

No.02



Soft Close Drawer Box Kit 2 450mm

No.04



Vantage Gallery Rails (Pair) \*two Pairs required For Double

No.05



Vantage Gallery Rail Bracket (Pair) Single Height 141mm

No.05a



Vantage Gallery Rail Bracket (Pair) Double Height 204mm

No.06



Soft Close 90 Degree Hinge

No.06a



Soft Close 45 Degree Hinge

No.06b



Soft Close 90 Degree Blind Corner Hinge



No.07



Soft Close 155 Degree Hinge

No.08



Backplate 1 Cam Adjust Screw Fix.

No.08a

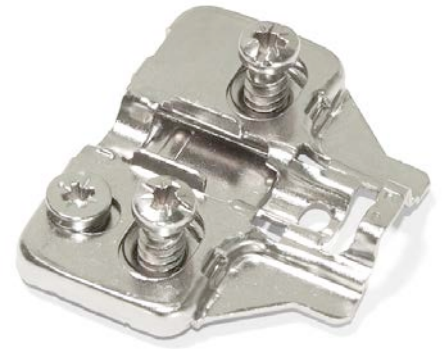

Backplate 2 Cam Adjust Euro Screw.

No.08b



Backplate 3 Clip Screw Fix.

No.08c



Backplate 4 Clip Euro Screw.

No.09 & 10



8kg & 11kg Gas Stay Kit

No.11 & 12



NSDX Lift and Stay  
(Left & Right)

No.13



NSDX Catch

No.14 No.15



Plasline Two Plinth 150mm x 4M



Plasline Two Flexible Angle Plinth 150mm x 4M

# Vertex Drawer Boxes

Shown in **Anthracite** - Also available in **White**

FITTINGS001VA



83mm Soft Close Drawer Kit - 450mm Deep

FITTINGS002VA

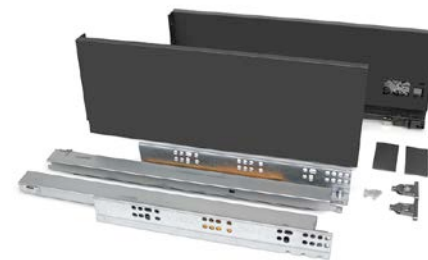

93mm Soft Close Drawer Kit - 450mm Deep

FITTINGS005VA



83mm Internal Drawer Front Fixing

FITTINGS006VA



93mm Internal Drawer Front Fixing

FITTINGS009VA



Gallery Rails i.nc Fixings

FITTINGS010VA

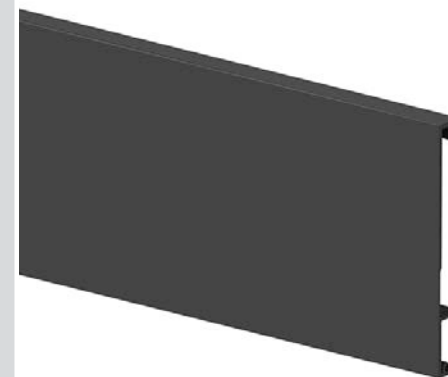

Internal Drawer Panel 93.5 x 1100mm  
(178mm requires Front Railing)





FITTINGS003VA



131mm Soft Close Drawer Kit - 450mm Deep

FITTINGS04VA



178mm Soft Close Drawer Kit - 450mm Deep

AGILE40VA & AGILE41VA



AGILE Flap Kit - For Door heights 650 - 729mm  
(Max. Door Width 1800mm) **40VA** upto 7.2kg **41VA** over 7.2kg

FITTINGS007VA



131mm Internal Drawer Front Fixing

FITTINGS08VA



178mm Internal Drawer Front Fixing

FITTINGS011VA

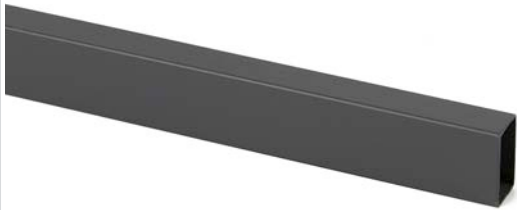

Internal Drawer Front Railing 1120mm  
(Required for 178mm)

FITTINGS030VA - 037VA



Base & Back 300mm to 1000mm wide (450mm Deep)  
Back Supplied @ 355mm for Assembly on site.

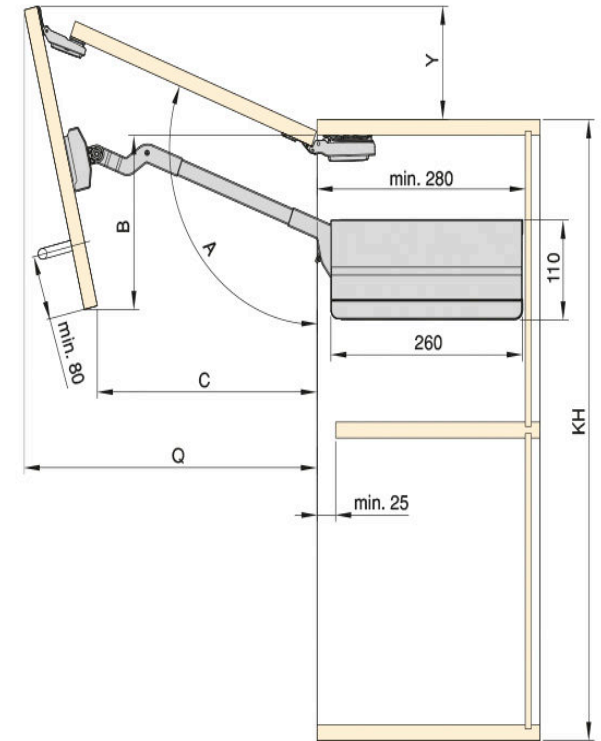

Model	A	B	C	Q	Y
<b>40VA</b>	~115-102°	160-228	335-226	355-428	144-74
<b>41VA</b>					

# Basics Range



*PTP900 - Single Bowl Sink 900mm*



*PTP1000 - Bowl and a Half Sink 1000mm*



*Orinoco - Twin Lever Chrome Tap*



*Obion - Single Lever Satin Tap*



*Pull Out - 600mm Extendable Extractor*



*Canopy - Canopy Style Extractor*



*Canopy UT07-52C ECO - Canopy Style Extractor*



*Fabita 600SS - Stainless Steel Extractor*



*Fabita 900SS - Stainless Steel Extractor*



*Fabita 600SSCG - Stainless Steel & Curved Glass Extractor*



*Fabita 900SSCG - Stainless Steel & Curved Glass Extractor*



# Door Key

For full details of Made To Order availability, please see current price list.



18mm Doors



Lacquered



Made to Order

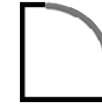

External Curved  
Doors Available



18mm Panels



Five Piece



Can Also be  
Painted to Order



Internal Curved  
Doors Available



22mm Doors



Solid Timber



Bedroom Available



Available from Stock



Handleless



Laser Edged



Vinyl Wrapped



**3D** solutions

*A New Dimension In Design*

All colours are as close as the reproduction process allows.